

ABOUT US

Ningbo Fortune Auto Parts Manufacture Co.,Ltd

Ningbo Fortune Auto Parts Manufacture Co., Ltd. specializes in auto parts manufacturing. Founded in 1996, Fortune is now one of the leading professional manufacturers of wheel balance weights, tire valves, and tool accessories. We are located in Ningbo, which is the most important port city in Yangtze Delta, China. Fortune has also set warehouses and offices in North America in 2014, which makes a better support for our global customers.



ISO/TS 16949:2009

ISO 9001:2008

PRODUCTION AND SERVICES

Under the principle of " To develop with technology and to survive with quality ", we built a professional team with over thirty engineers who keep innovation and quality control in mind to serve worldwide markets. We also keep on introducing new automation equipments to enlarge our production capacity and improve our technology, and now our products have been sold to OEM'S and aftermarket customers across Americas, Europe, Japan, Asia, and Oceania.



QUALITY CONTROL

We monitor each process in production. Product development and design are performed by experienced engineers and technicians. We do strict inspection on each product to reinforce excellent quality. Our packaging is also checked in-line to ensure accuracy. Before each shipment, we make sure the quantity on the order and on the delivery slip is the same.



CONTENTS



03 Wheel Weights

Adhesive Wheel Weights

Steel	4-8
Zinc	8
Lead	9
Roll	10

Clip-on wheel weights

Wheel Weights for North America	13-18
Zinc	19-20
Lead	21-22
Package	23-24

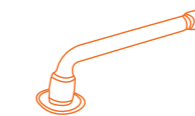

25 Tire Valves&Accessories

TPMS	26-27
Tire Valves	28-36
Valve Core	37
Valve Caps	38
Valve Extensions	39
Valve Chucks	40/46
Tire Studs	41-42



43 Tire Pressure Gauges

Digital Tire Pressure Gauges	44
Pencil-like Tire Air Gauges	45
Tire Tread Depth Gauges	45
Inflator Gauges	45-46



47 Lug Nuts, Bolts&Wheel Spacer, Adapters

Lug Nuts	48
Lug Bolts	49
Wheel Locks	50
Wheel Spacer	51
Wheel Adapter	52



53 Tire Repair Tools









Pistol Grip Tools	54
Valve Tools	55
Stitchers&Scrapers	56
Tire Repair Kits	57
Euro Style Patches	58
US Style Patches	59
Gloves	60



61 Wheel

Steel Wheels	62
--------------	----



-  Zinc
-  Steel
-  Lead
-  With FYC Icon
-  With F Icon
-  Trapezium Shape
-  Corrosion protection
-  Alloy rims
-  Steel rims

WHEEL WEIGHTS

Ningbo Fortune has been manufacturing wheel weights for over 20 years. Our production development and design are performed by experienced engineer and technician teams. Production is closely monitored. Our powder coating system makes sure best appearance, thickness, and corrosive protection.



Coating Colours Available Upon Request

Why use steel for adhesive balance weights?

Steel is the most environment and ecological balance weight solution. Fortune has pioneered the use of steel as a material for balance weights. Steel is the natural choice as a balance weight material.

- The best environmental and ecological solution. Easy on the environment, ground water, and for recycling
- The most widely used automotive material
- A more stable price as it is not a traded commodity (unlike zinc and lead)

Why use Fortune adhesive weights?

Fortune has been manufacturing wheel weights since 1996. Our adhesive strips have a superior corrosion resistance. After lab salt spray testing of Fortune wheel weight and our competitor's weight. Fortune wheel weight, on the left, stays the same. On the contrary, the other one is already corroded.

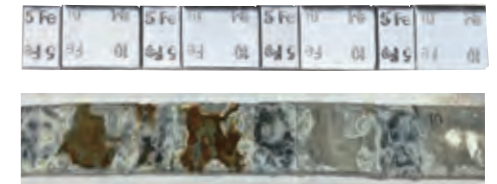

Features

- A shift to lead-free alternatives
- Proven long-lasting coating for corrosion protection
- Available in different tape types
- Design segments allows for easier contouring to the wheel shape when installing

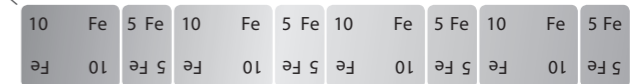

EasyPeel Tapes

You can choose Fortune Easy Peel tapes. The tape backing is wider than the weight, making the removal process more efficient.



Diverse shapes

Fortune provides diverse shapes of adhesive wheel weights. Our popular Low Profile adhesive weights have much thinner segments than others. It helps prevent weights from scratching and wearing out, as well as easier contouring. Our Trapezium segments allow for easier contouring to the wheel shape when installing.

Low Profile Segments

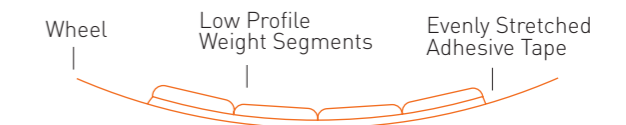

Trapezium Segments



Application of Adhesive Weights



Preparatory work

Rotate the tyre and determine the wheel imbalance in both planes. Ensure that the weight, rim and ambient temperature have at least 15°C. Clean the rims with an appropriate cleaning agent to avoid grease and silicone residues on the rim. Be sure to test the cleaning agent on a small area to ensure it will not damage the wheel's finish.

Adjusting the adhesive weight to the rim contour

Adjust the adhesive weight with the protective foil to the rim radius. The radius of the weight body and the rim must run at least parallel to each other. It is even better, if the radius of the weight body is smaller than the rim radius.

Removing the protective foil

After having adjusted the weight to the rim radius, peel off the protective backing without touching the adhesive.

Assembling the weight

Now press the weight to the rim from the middle towards the outer edges. The pressure should be at least 100kPa.



Steel Adhesive Wheel Weights (gram)

FSF01



Weight Size : 5g*4+10g*4 segments, 60g/strip
Surface: Zinc plated or plastic coated
Packaging: 100 strips/box, 4 boxes/case



FSF01-2



Weight Size : 5g*4+10g*4 segments, 60g/strip
Surface: Zinc plated or plastic coated
Packaging: 100 strips/box, 4 boxes/case



FSF01-1



Weight Size : 5g*4+10g*4 segments, 60g/strip
Surface: Zinc plated or plastic coated
Packaging: 100 strips/box, 4 boxes/case



FSF02



Weight Size : 5g*12 segments, 60g/strip
Surface: Zinc plated or plastic coated
Packaging: 100 strips/box, 4 boxes/case



FSF02-1



Weight Size : 5g*12 segments, 60g/strip
Surface: Zinc plated or plastic coated
Packaging: 100 strips/box, 4 boxes/case



FSF02-2



Weight Size : 5g*12 segments, 60g/strip
Surface: Zinc plated or plastic coated
Packaging: 100 strips/box, 4 boxes/case



Steel Adhesive Wheel Weights (ounce)

FSF07





Weight Size : 1/2oz*9 segments, 4.5oz/strip
 1/2oz*12 segments, 6oz/strip
Thickness: 4mm, 6mm
Surface: Zinc plated or plastic coated
Packaging: 40 strips/box, 4 boxes/case
 30 strips/box, 4 boxes/case







Steel Adhesive Wheel Weights (ounce)

FSF07-1  



Weight Size : 1/2oz*6segments, 3oz/strip
Thickness: 3mm
Surface: Zinc plated or plastic coated
Packaging: 24 strips/box, 8 boxes/case



FSF08-01  



Weight Size : 1/4oz*12 segments, 3oz/strip
 1/4oz*10 segments, 2.5oz/strip
Surface: Zinc plated or plastic coated
Packaging: 52 strips/box, 4 boxes/case
 65 strips/box, 4 boxes/case



FSF07-2  



Weight Size : 1/2oz*8segments, 4 oz/strip
Thickness: 4mm, 6mm
Surface: Zinc plated or plastic coated
Packaging: 24strips/box,8boxes/case



FSF08-2  

Weight Size : 1/4oz*12 segments, 3oz/strip
 1/4oz*10 segments, 2.5oz/strip
Surface: Zinc plated or plastic coated
Packaging: 52 strips/box, 4 boxes/case
 65 strips/box, 4 boxes/case



FSF08  

Weight Size : 1/4oz*12 segments, 3oz/strip
 1/4oz*10 segments, 2.5oz/strip
Surface: Zinc plated or plastic coated
Packaging: 52 strips/box, 4 boxes/case
 65 strips/box, 4 boxes/case





FSF09  

Weight Size : 1oz*6 segments, 6oz/strip
Surface: Zinc plated or plastic coated
Packaging: 32 strips/box, 4 boxes/case



Trapezium Adhesive Wheel Weights

FSF02T  



Weight Size : 5g*12 segments, 60g/strip
Surface: Zinc plated or plastic coated



FSF03T  

Weight Size : 1/4oz*12 segments, 3oz/strip
Surface: Zinc plated or plastic coated



FSF07T  

Weight Size : 1/2oz*12 segments, 3oz/strip
Surface: Zinc plated or plastic coated





FSF08T  

Weight Size : 1/4oz*12 segments, 3oz/strip
Surface: Zinc plated or plastic coated





Zinc Adhesive Wheel Weights

FSZ05  



Weight Size : 5g*12 segments, 60g/strip,
 also available in roll
Surface: plastic coated
Packaging: 100 strips/box, 4 boxes/case

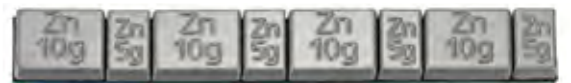

FSZ06  

Weight Size : 5g*4segments+10g*4segments,
 60g/strip
Surface: plastic coated
Packaging: 100 strips/box, 4 boxes/case





FSZ07  



Weight Size : 1/4oz*12 segments, 3oz/strip
 1/4oz*10 segments, 2.5oz/strip
Surface: plastic coated
Packaging: 52 strips/box, 4 boxes/case
 65 strips/box, 4 boxes/case





Lead Adhesive Wheel Weight

FSL01  
Weight Size : 5g*12 segments, 60g/strip
Surface: Natural Color or Plastic Coated
Packaging: 50 strips/box, 10 boxes/case





FSL02  
Weight Size : 5g*4+10g*4 segments, 60g/strip
Surface: Natural Color or Plastic Coated
Packaging: 50 strips/box, 10 boxes/case





FSL03  
Weight Size : 1/4oz*12 segments, 3oz/strip
Surface: Natural Color or Plastic Coated
Packaging: 52 strips/box, 4boxes/case





FSL04  
Weight Size : 1/2oz*12 segments, 6oz/strip
Surface: Natural Color or Plastic Coated
Packaging: 30 strips/box, 4 boxes/case



FSL06  
Weight Size : 50g*4 segments, 200g/strip
Surface: Natural Color or Plastic Coated
Packaging: 30 strips/box, 4 boxes/case



FSL07  
Weight Size : 1oz*6 segments, 6oz/strip
Surface: Natural Color or Plastic Coated
Packaging: 30 strips/box, 4 boxes/case



Roll Adhesive Wheel Weights





Art No.	Description	Packaging
FSR01-1	Steel 5g	5kg or 6kg/roll
FSR01-2	Steel 1/4 oz	5kg or 6kg/roll
FSR01-3	Steel 1/2oz(4mm)	4.2kg or 5kg/roll
FZR01	Zinc 5g	5kg or 6kg/roll
FZR01-2	Zinc 1/4oz	5kg/roll



Art No.	Description	Packaging
FSR02-1	Steel 5g	5kg or 6kg/roll
FSR02-2	Steel 1/4 oz	5kg or 6kg/roll
FSR02-3	Steel 1/2oz(4mm)	4.2kg or 5kg/roll
FZR02-1	Zinc 5g	5kg or 6kg/roll
FZR02-2	Zinc 1/4oz	5kg/roll



Tape Options and Feature

	US White 	US Black 	3M RED	Cold Weather	China Blue	Norton Blue
Base material color	White	Black	Grey	Grey	Black	Black
Liner colour	White	White	Red	Red	Blue,Red,White	Blue
Liner material	Easy release paper	Easy release paper	Plastic with 3M logo	Plastic	Plastic	Plastic
Foam	Polyethylene	Polyethylene	Acrylic (high temperature resistant)	Acrylic	Polyethylene	Acrylic (high temperature resistant)
Re-positionable	No	No	yes	Yes	No	yes
Initial tack	Excellect	Excellect	Fair	Fair	Good	Fair
Adherence after 24h	Excellect	Excellect	Excellect	Excellect	Excellect	Excellect
Resistance to high temperature	Good	Good	Excellect	Good	Fair	Excellect

Installation Diagram:



Tape:

Tapes available in regular and EasyPeel style





CLIP-ON WHEEL WEIGHTS

Our lead-free alternative wheel weights are environmentally friendly for application to all rims. Plastic coated feature to OE standards for a higher level of corrosion resistance.

Application of Clip-On wheel weights



Select the correct application

Using a wheel weight application guide, select the correct application for the vehicle you are servicing. Check that the weight application is correct by testing the placement on the wheel flange.

Placing the wheel weight

Place the wheel weight in the correct location of the imbalance. Prior to striking the clip with the hammer, make sure that the top and the bottom of the clip are touching the rim flange. The body of the weight should not be touching the rim!

Installation

Once the wheel weight is properly aligned, strike the clip with a proper wheel weight installation hammer. Please note: striking the weight body could result in clip retention failure or weight movement.

Checking the weight

After installing the weight, check to make sure that it is secured properly.

Steel Clip-on Wheel Weight for North America

Features

- Steel is the most environmental material.
- Corrosion resistance for five years.
- Zinc plated or plastic powder coated.
- Clips can be used more than 10 times.
- Strict salt-spray lab tested.

- Corrosion protection
- Alloy rims
- Steel rims



- Corrosion protection
- Steel rims

PFE

0.25 to 3oz The most common weight for steel wheels, Will fit standard-width rim flange thickness passenger car steel wheels with 13"-17" wheel size.

FITS Standard-width rim flange thickness passenger car steel wheels with 13"-17" wheel size.



- Corrosion protection
- Alloy rims

MCFE

0.25 to 3oz Most North American vehicles equipped with alloy rims. The MC-Series is the most sold & installed wheel weight for alloy rims.

FITS Many brands like Buick, Chevrolet, Chrysler, Dodge, Ford, Mazda, Oldsmobile, Pontiac & Saturn



- Corrosion protection
- Alloy rims

AWFE

0.25 to 3oz North American vehicles equipped with alloy rims that were manufactured prior to 1995.

FITS Many brands like Acura, Buick, Chevrolet, Chrysler, Dodge, Infiniti, Isuzu, Lexus, Oldsmobile & Pontiac



- Corrosion protection
- Alloy rims

IAWFE

5 to 60g Many new Ford models, on most European vehicles and certain Asian vehicles equipped with alloy wheels.

FITS Many brands like Audi, BMW, Cadillac, Jaguar, Kia, Nissan, Toyota, Volkswagen & Volvo



- Corrosion protection
- Alloy rims

FNFE

5 to 60g Most Japanese vehicles equipped with alloy wheels. Application to most Japanese vehicles.

FITS Many brand like Acura, Honda, Infiniti, Lexus, Nissan & Toyota



- Corrosion protection
- Alloy rims

ENFE

5 to 60g Audi, Mercedes-Benz, Volkswagen and very early-model Japanese vehicles equipped with alloy wheels.

FITS Many brands like Acura, Audi, Ford, Honda, Mercedes-Benz & Volkswagen



- Corrosion protection
- Steel rims

TFE

0.25 to 3oz Most North American light trucks equipped with decorative and larger thickness steel wheels and most light-trucks equipped with alloy wheels.

FITS Steel Wheels with a thicker than standard rim flange and light-trucks with non-commercial alloy rims



- Corrosion protection
- Alloy rims

LHFE

0.25 to 3oz Chrysler vehicles and is designed to fit their unique alloy rim flange.

FITS All Chrysler models and some Dodge & Ram models prior to 2009

Lead Clip-on Wheel Weights for North America



PPB
0.25 to 3oz

The most common weight for steel wheels, Will fit standard-width rim flange thickness passenger car steel wheels with 13"-17" wheel size.

FITS Standard-width rim flange thickness passenger car steel wheels with 13"-17" wheel size.

Corrosion protection Steel rims



MCPB
0.25 to 3oz

Most North American vehicles equipped with alloy rims. The MC-Series is the most sold & installed wheel weight for alloy rims.

FITS Many brands like Buick, Chevrolet, Chrysler, Dodge, Ford, Mazda, Oldsmobile, Pontiac & Saturn.

Corrosion protection Alloy rims



AWPB
0.25 to 3oz

North American vehicles equipped with alloy rims that were manufactured prior to 1995.

FITS Many brands like Acura, Buick, Chevrolet, Chrysler, Dodge, Infiniti, Isuzu, Lexus, Oldsmobile & Pontiac.

Corrosion protection Alloy rims



IAWPB
5 to 60g

Many new Ford models, on most European vehicles and certain Asian vehicles equipped with alloy wheels.

FITS Many brands like Audi, BMW, Cadillac, Jaguar, Kia, Nissan, Toyota, Volkswagen & Volvo.

Corrosion protection Alloy rims



FNPB
5 to 60g

Most Japanese vehicles equipped with alloy wheels. Application to most Japanese vehicles

FITS Many brand like Acura, Honda, Infiniti, Lexus, Nissan & Toyota.

Corrosion protection Alloy rims





ENPB
5 to 60g

Audi, Mercedes-Benz, Volkswagen and very early-model Japanese vehicles equipped with alloy wheels.

FITS Many brands like Acura, Audi, Ford, Honda, Mercedes-Benz & Volkswagen.

Corrosion protection Alloy rims



TPB
0.25 to 3oz

Most North American light trucks equipped with decorative and larger thickness steel wheels and most light-trucks equipped with alloy wheels.

FITS Steel Wheels with a thicker than standard rim flange and light-trucks with non-commercial alloy rims

Corrosion protection Steel rims



LHPB
0.25 to 3oz

Chrysler vehicles and is designed to fit their unique alloy rim flange.

FITS All Chrysler models and some Dodge & Ram models prior to 2009.

Corrosion protection Alloy rims

Zinc Clip-on Wheel Weights for North America



Corrosion protection Steel rims

PZN
0.25 to 3oz The most common weight for steel wheels, Will fit standard-width rim flange thickness passenger car steel wheels with 13"-17" wheel size.
FITS Standard-width rim flange thickness passenger car steel wheels with 13"-17" wheel size.



Corrosion protection Alloy rims

MCZN
0.25 to 3oz Most North American vehicles equipped with alloy rims. The MC-Series is the most sold & installed wheel weight for alloy rims.
FITS Many brands like Buick, Chevrolet, Chrysler, Dodge, Ford, Mazda, Oldsmobile, Pontiac & Saturn



Corrosion protection Alloy rims

AWZN
0.25 to 3oz North American vehicles equipped with alloy rims that were manufactured prior to 1995.
FITS Many brands like Acura, Buick, Chevrolet, Chrysler, Dodge, Infiniti, Isuzu, Lexus, Oldsmobile & Pontiac.



Corrosion protection Alloy rims

IAWZN
5 to 60g Many new Ford models, on most European vehicles and certain Asian vehicles equipped with alloy wheels.
FITS Many brands like Audi, BMW, Cadillac, Jaguar, Kia, Nissan, Toyota, Volkswagen & Volvo.



Corrosion protection Alloy rims

FNZN
5 to 60g Most Japanese vehicles equipped with alloy wheels. Application to most Japanese vehicles.
FITS Many brand like Acura, Honda, Infiniti, Lexus, Nissan & Toyota.



Corrosion protection Alloy rims

ENZN
5 to 60g Audi, Mercedes-Benz, Volkswagen and very early-model Japanese vehicles equipped with alloy wheels.
FITS Many brands like Acura, Audi, Ford, Honda, Mercedes-Benz & Volkswagen.



Corrosion protection Steel rims

TZN
0.25 to 3oz Most North American light trucks equipped with decorative and larger thickness steel wheels and most light-trucks equipped with alloy wheels.
FITS Steel Wheels with a thicker than standard rim flange and light-trucks with non-commercial alloy rims.







Corrosion protection Alloy rims

LHZN
0.25 to 3oz Chrysler vehicles and is designed to fit their unique alloy rim flange.
FITS All Chrysler models and some Dodge & Ram models prior to 2009.

Zinc Casting Clip-on Wheel Weights





Application to steel wheels, plastic coated Lead-free alternative is environmentally friendly

Art. No.	Description	Qty/box
FCZ03-05	5g	100pc
FCZ03-10	10g	100pc
FCZ03-15	15g	100pc
FCZ03-20	20g	100pc
FCZ03-25	25g	100pc
FCZ03-30	30g	100pc
FCZ03-35	35g	50pc
FCZ03-40	40g	50pc
FCZ03-45	45g	50pc
FCZ03-50	50g	50pc
FCZ03-55	55g	50pc
FCZ03-60	60g	50pc

-  Corrosion Protection
-  Steel Rims
-  Zinc
-  Passenger Cars



Art. No.	Description	Qty/box
FCZ04-05	5g	100pc
FCZ04-10	10g	100pc
FCZ04-15	15g	100pc
FCZ04-20	20g	100pc
FCZ04-25	25g	100pc
FCZ04-30	30g	100pc
FCZ04-35	35g	50pc
FCZ04-40	40g	50pc
FCZ04-45	45g	50pc
FCZ04-50	50g	50pc
FCZ04-55	55g	50pc
FCZ04-60	60g	50pc



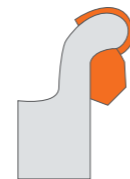

-  Corrosion Protection
-  Alloy Rims
-  Zinc
-  Passenger Cars



Zinc Die-casting Clip-on Wheel Weights





Application to steel wheels, plastic coated Lead-free alternative is environmentally friendly

Art. No.	Description	Qty/box
FCZ05-05	5g	100pc
FCZ05-10	10g	100pc
FCZ05-15	15g	100pc
FCZ05-20	20g	100pc
FCZ05-25	25g	100pc
FCZ05-30	30g	100pc
FCZ05-35	35g	50pc
FCZ05-40	40g	50pc
FCZ05-45	45g	50pc
FCZ05-50	50g	50pc
FCZ05-55	55g	50pc
FCZ05-60	60g	50pc

-  Corrosion Protection
-  Steel Rims
-  Zinc
-  Passenger Cars



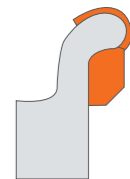

Art. No.	Description	Qty/box
FCZ06-05	5g	100pc
FCZ06-10	10g	100pc
FCZ06-15	15g	100pc
FCZ06-20	20g	100pc
FCZ06-25	25g	100pc
FCZ06-30	30g	100pc
FCZ06-35	35g	50pc
FCZ06-40	40g	50pc
FCZ06-45	45g	50pc
FCZ06-50	50g	50pc
FCZ06-55	55g	50pc
FCZ06-60	60g	50pc

-  Corrosion Protection
-  Alloy Rims
-  Zinc
-  Passenger Cars



Lead Clip-On Wheel Weights

Art. No.	Description	Qty/box
FCL01-05	5g	100pc
FCL01-10	10g	100pc
FCL01-15	15g	100pc
FCL01-20	20g	100pc
FCL01-25	25g	100pc
FCL01-30	30g	100pc
FCL01-35	35g	50pc
FCL01-40	40g	50pc
FCL01-45	45g	50pc
FCL01-50	50g	50pc
FCL01-55	55g	50pc
FCL01-60	60g	50pc





-  Corrosion Protection
-  Lead
-  Steel Rims
-  Passenger Cars



Application to steel wheels



Art. No.	Description	Qty/box
FCL02-05	5g	100pc
FCL02-10	10g	100pc
FCL02-15	15g	100pc
FCL02-20	20g	100pc
FCL02-25	25g	100pc
FCL02-30	30g	100pc
FCL02-35	35g	50pc
FCL02-40	40g	50pc
FCL02-45	45g	50pc
FCL02-50	50g	50pc
FCL02-55	55g	50pc
FCL02-60	60g	50pc

-  Corrosion Protection
-  Lead
-  Alloy Rims
-  Passenger Cars





Application to alloy wheels



Lead Clip-On Wheel Weights

Art. No.	Description	Qty/box
FCL04-50	50g	50pc
FCL04-100	100g	25pc
FCL04-120	120g	25pc
FCL04-150	150g	25pc
FCL04-200	200g	25pc
FCL04-250	250g	25pc
FCL04-300	300g	25pc
FCL04-350	350g	25pc

-  Corrosion Protection
-  Lead
-  Light Truck



Application to light truck

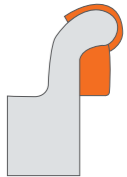

Art. No.	Description	Qty/box
FCL03-50	50g	50pc
FCL03-100	100g	25pc
FCL03-150	150g	10 pc
FCL03-200	200g	10pc
FCL03-250	250g	10pc
FCL03-300	300g	10pc
FCL03-350	350g	10pc
FCL03-400	400g	10pc
FCL03-450	450g	10pc
FCL03-500	500g	10pc

-  Corrosion Protection
-  Lead
-  Heavy Truck



Application to heavy truck

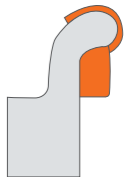



RACKING FOR ADHESIVE WHEEL WEIGHTS



FR01



FR08



FR02



FR03

CLIP-ON RACKING FOR NORTH AMERICA



FR06



FR06



FR07

PACKAGE FOR WHEEL WEIGHTS



FP01

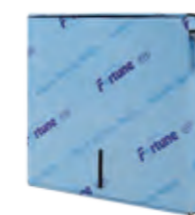

FP02



FP03



FP04



FP05



TIRE VALVES & ACCESSORIES

Fortune manufactures high quality valves, which are International high standard EPDMs, copper based valve series, aluminum based valve series. They are ideally designed for passenger cars and commercial vehicles. Our TPMS service kits has obtained TUV and TS16949 certifications

Why use Fortune's tire valves?

Copper Valve Comparison

- **Fortune Premium Truck Valve** uses high quality EPDM rubber and premium copper rod. We guarantee product sealability and user safety. All of our truck tire valves are produced with premium copper and CNC processing machines, which create high precision and smooth surfaces.
- Inferior Valve has obvious scratches and blemishes on its surface. Poor processing equipments cause the size of each part of valves not accurate. A inferior valve has lower copper content, smaller external dimension, larger holes on the bottom to reduce material usage. Inferior Valve uses zinc alloy main rod and inferior natural rubber. Zinc alloy valves have poor sealability and material stability. They tend to crack and age. Also, Inferior natural rubber will easily age in the air and break during installation. Therefore, user safety is not guaranteed.



Rubber Valve difference

- **Fortune Premium Valve** uses high quality EPDM rubber and premium copper rod. Therefore, we guarantee product sealability and user safety.
- Inferior Valve uses zinc alloy main rod and inferior natural rubber. Zinc alloy valves have poor sealability and material stability. They tend to crack and age. Also, Inferior natural rubber will easily age in the air and break during installation. Therefore, the safety performance is not guaranteed.



Rubber TPMS Valve & Metal TPMS Valve

A tire valve is a safety critical component and only valves from known quality sources are recommended. Low quality valves can cause rapid tyre deflation with vehicles becoming uncontrollable and potentially crashing. It is for this reason that Fortune only sells from OE quality valves with ISO/TS16949 accreditation.



TPMS SERVICE KITS

Component like:

- Valve cap
- Valve nut
- Rubber grommet
- And the proper valve core

F1030K

TPMS, Service Kit VW (Siemens)

REFERENCE PART NUMBERS:

SCHRADER KIT: 20017

NAPA KIT: 92-0235

DILL KIT: D1030K

APPLICATION DATA:

NUT TORQUE(in-lbs): 71

NUT TORQUE(N-m): 8

CORE TORQUE(in-lbs): 2-5

CORE TORQUE(N-m): 23-56



F1040K

TPMS, Service Kit Beru Valve

REFERENCE PART NUMBERS:

SCHRADER KIT: 20023

DILL KIT: D1040K

APPLICATION DATA:

NUT TORQUE(in-lbs): 35

NUT TORQUE(N-m): 4

CORE TORQUE(in-lbs): 2-5

CORE TORQUE(N-m): 23-56



F1060K

TPMS, Service Kit Ford (Schrader)

REFERENCE PART NUMBERS:

SCHRADER KIT: 20002

NAPA KIT: 92-0115

DILL KIT: D1060K

APPLICATION DATA:

NUT TORQUE(in-lbs): 44

NUT TORQUE(N-m): 5

CORE TORQUE(in-lbs): 2-5

CORE TORQUE(N-m): 23-56



F1090K

TPMS, Service Kit for Beru Sensors

REFERENCE PART NUMBERS:

SCHRADER KIT: 20023

NAPA KIT: 92-0261

DILL KIT: D1090K

APPLICATION DATA:

NUT TORQUE(in-lbs): 35

NUT TORQUE(N-m): 4

CORE TORQUE(in-lbs): 2-5

CORE TORQUE(N-m): 23-56



F1098K

TPMS, Service Kit Valve For Siemens Sensors

REFERENCE PART NUMBERS:

DILL KIT: D1098K

APPLICATION DATA:

NUT TORQUE(in-lbs): 35

NUT TORQUE(N-m): 4

CORE TORQUE(in-lbs): 2-5

CORE TORQUE(N-m): 23-56



F2000K

TPMS,
Service Kit Acura &
Honda / Hyundai & Kia
(Entire)



F2010K

TPMS, Service Kit Volvo (Schrader)

REFERENCE PART NUMBERS:

SCHRADER KIT: 20009

DILL KIT: D2010K

APPLICATION DATA:

NUT TORQUE(in-lbs): 62

NUT TORQUE(N-m): 7

CORE TORQUE(in-lbs): 2-5

CORE TORQUE(N-m): 23-56



F2030K

TPMS, Service Kit Chrysler (Schrader)

REFERENCE PART NUMBERS:

SCHRADER KIT: 20013

NAPA KIT: 92-0225/0230/0210

DILL KIT: D2030K

APPLICATION DATA:

NUT TORQUE(in-lbs): 35-71

NUT TORQUE(N-m): 4-8

CORE TORQUE(in-lbs): 2-5

CORE TORQUE(N-m): 23-56



Passenger Car & Light Truck Snap-In Tubeless Valve



*TR413 Series

Max cold inflating pressure 450kpa/65psi at room temperature

NRNO.	Rim Hole	Eff.length (mm)	Parts		A	B	C
			core	cap			
TR412	Φ 11.5/.453"	22	9002#	VC8	33	22	15
TR413	Φ 11.5/.453"	30	9002#	VC8	42.5	32	15
TR414	Φ 11.5/.453"	38	9002#	VC8	48.5	38	15
TR414L	Φ 11.5/.453"	45	9002#	VC8	56.5	46	15
TR418	Φ 11.5/.453"	49	9002#	VC8	61.5	51	15
TR423	Φ 11.5/.453"	62	9002#	VC8	74	63.5	15
TR415	Φ 16/.626"	30	9002#	VC8	42.5	32	19.2
TR425	Φ 16/.626"	49	9002#	VC8	61.5	51	19.2
TR438	Φ 8.8/.346"	32	9002#	VC8	40.5	31	11

Colors Available For Aluminum Valves



*TR413 Series Decorate-Sleeve & Cap Valves



Passenger Car & Light Truck Snap-In Tubeless Valves

*Tubeless Metal Clamp-in Valve



MS525AL-B (Brass)



MS525AL (Brass)



MS525AL (Aluminum)



MS525AL (Aluminum)

For 11.5 (.453" dia) Rim Holes

TRNO.	Eff. length (mm)	Parts			
		Grommet	Washer	Nut	Cap
MS525S	Φ 17.5x41.5	RG9, RG54	RW15	HN6	FT
MS525L	Φ 17.5x41.5	RG9, RG54	RW15	HN7	FT
MS525AL	Φ 17x42	RG9, RG54	RW15	HN9	FT



TR542



TR416



TR416L



TR416SS

TRNO.	Eff. length (mm)	Rim Hole (mm/in.)	Parts			
			Grommet	Washer	Nut	Cap
V2.04.1	Φ 17.5x35	Φ 11.5/.453"	V9.11.7		V9.7.1FT	FT
TR416	Φ 18.5x40	Φ 16/.625"	RG39	RW13	HN4	FT
TR416B	Φ 17x38/34	Φ 16/.625"	RG54	RW8	HN4	FT
TR416S	Φ 17x40	Φ 11.5/.453"	RG54	RW8	HN4	FT
TR416L	Φ 16.7x59	Φ 11.5/.453"	RG59	RW8	HN4	FT
TR416SS	Φ 14x38	Φ 11.5/.453"	V801	RW8	RW8	FT
TR416SSS	Φ 14x39	Φ 8.3/.327"	RG11	RW6	RW8	FT

Passenger Car & Light Truck

*Tubeless Metal Clamp-in Valve



*Tubeless Metal Clamp-in Valve



TRNO.	Eff. length (mm)	Rim Hole (mm/in.)	Parts			
			Grommet	Washer	Nut	Cap
TR5991B	Φ 19x34	Φ 11.5/.453"	HRG39	RW8	HN4	AT
V-3	Φ 14x33	Φ 11.5/.453"	HRG2x2	RW5	HN2x2	ET/BT
V-4	Φ 14x34	Φ 11.5/.453"	HRG2x2	RW5	HN2x2	ET/BT
V-5	Φ 14x48	Φ 11.5/.453"	HRG2x2	RW5	HN2x2	ET/BT
V-6	Φ 14x53	Φ 11.5/.453"	HRG2x2	RW5	HN2x2	ET/BT
VS-6	Φ 11x40	Φ 6/.236"	RG54	RW8	HN4	ET/BT
V-7	Φ 14x63	Φ 11.5/.453"	HRG2x2	RW5	HN2x2	ET/BT
V-8	Φ 16x34	Φ 11.5/.453"	HRG1, HG2	RW12	HN2x2	ET/BT
VS-8	Φ 16x38	Φ 11.5/.453"	HRG1, HG2	RW12	HN2x2	ET/BT
V-9	Φ 16x43	Φ 11.5/.453"	HRG1, HG2	RW12	HN2x2	ET/BT
VS-8-45	Φ 16x53-45°	Φ 11.5/.453"	HRG1, HG2	RW12	HN2x2	ET/BT
VS-8-90	Φ 16x63-90°	Φ 11.5/.453"	HRG1, HG2	RW12	HN2x2	ET/BT
TR6008C	Φ 17.5x34	Φ 16/.625"	RG39	RW8	HN4x2	DT
PVR152	Φ 17x70-90°	Φ 11.5/.453"	RG54	RW8	HN4	ET/BT
PVR153	Φ 16x65-90°	Φ 11.5/.453"	RG54	RW8	HN4	ET/BT
TR435	Φ 19x34	Φ 11.5/.453"	RG54	RW8	HN4	ET/BT

Tubeless Metal Clamp-In Valve

*TR500C Series Bent Valves



*TR500 Series Straight Valves



For Ø16/.625" Rim Holes

TRNO.	ETRTO NO. (REF.NO.)	Eff.Length (mm)	Parts				
			Core	Grommet	Washer	Nut	Cap
TR500	V3.21.3	Φ19x55	9002#	RG15	RW8	HN13	VC2/VC3
TR501	V3.21.2	Φ19x42	9002#	RG15	RW8	HN13	VC2/VC3
TR502	64MS15.7	Φ19x64	9002#	RG15	RW8	HN13	VC2/VC3
TR570	V3.21.4	Φ19x84	9002#	RG15	RW8	HN13	VC2/VC3
TR571	V3.21.5	Φ19x90	9002#	RG15	RW8	HN13	VC2/VC3
TR572	V3.21.6	Φ19x100	9002#	RG15	RW8	HN13	VC2/VC3
TR573	V3.21.7	Φ19x115	9002#	RG15	RW8	HN13	VC2/VC3
TR574	V3.21.8	Φ19x131	9002#	RG15	RW8	HN13	VC2/VC3
TR575	V3.21.1	Φ19x33	9002#	RG15	RW8	HN13	VC2/VC3
TR570C	V3.21.9	Φ19x84/90°or27°	9002#	RG15	RW8	HN13	VC2/VC3
TR571C	V3.21.10	Φ19x90/90°or27°	9002#	RG15	RW8	HN13	VC2/VC3
TR572C	V3.21.11	Φ19x100/90°or27°	9002#	RG15	RW8	HN13	VC2/VC3
TR573C	V3.21.12	Φ19x115/90°or27°	9002#	RG15	RW8	HN13	VC2/VC3
TR574C		Φ19x131/90°or27°	9002#	RG15	RW8	HN13	VC2/VC3
TR500-23	VS-1223R	Φ19x55/23°	9002#	RG15	RW8	HN13	VC2/VC3
TR570P		Φ22x18	9002#	RG7	RW11	HN11	VC2/VC3

Tubeless Nickel Plated O-Ring Seal Clamp-In Valves

*TR540 Series Valves



*Rim hole .382".394" [9.7-10mm]



TRNO.	Parts				A	B	β
	Core	Grommet	Nut	Cap			
TR542	9002#	RG60	HN21	VC2/VC3	32		
TR543	9002#	RG60	HN21	VC2/VC3	59		
TR544	9002#	RG60	HN21	VC2/VC3	73		
TR545	9002#	RG60	HN21	VC2/VC3	90		
TR546	9002#	RG60	HN21	VC2/VC3	108		
TR543C	9002#	RG60	HN21	VC2/VC3	24	35	45
TR543D	9002#	RG60	HN21	VC2/VC3	25	35	60
TR543E	9002#	RG60	HN21	VC2/VC3	25	35	75
TR544D	9002#	RG60	HN21	VC2/VC3	25	49	60
TR544E	9002#	RG60	HN21	VC2/VC3	25	49	75
TR545B	9002#	RG60	HN21	VC2/VC3	35	55.8	26
TR545-36	9002#	RG60	HN21	VC2/VC3	25	66	36
TR545D	9002#	RG60	HN21	VC2/VC3	25	66	60
TR545E	9002#	RG60	HN21	VC2/VC3	25	66	75
TR546B	9002#	RG60	HN21	VC2/VC3	25	85	26
TR546-36	9002#	RG60	HN21	VC2/VC3	25	85	36
TR546D	9002#	RG60	HN21	VC2/VC3	25	85	60
TR546E	9002#	RG60	HN21	VC2/VC3	25	85	75
TR547D					25	96	60

TRNO.	ETRTO NO.	Eff.Length (mm)	Parts			
			Core	Grommet	Nut	Cap
TR509	8713	Φ23x138.5/90°	9002#	RG46	HN17	VC2/VC3
TR510	8717	Φ23x157.5/90°	9002#	RG46	HN17	VC2/VC3
TR511	8711	Φ23x126/90°	9002#	RG46	HN17	VC2/VC3
	V3-20-1	Φ16x41	9002#	RG60	V9.07.2	VC2/VC3
	V3-20-2	Φ16x95/17.50	9002#	RG60	V9.07.2	VC2/VC3
	V3-20-3	Φ16x82	9002#	RG60	V9.07.2	VC2/VC3
	V3-20-4	Φ16x90/27°	9002#	RG60	V9.07.2	VC2/VC3
	V3-20-5	Φ16x70/27°	9002#	RG60	V9.07.2	VC2/VC3
	V3-20-6	Φ16x115/27°	9002#	RG60	V9.07.2	VC2/VC3
	V3-20-7	Φ16x80/27°	9002#	RG60	V9.07.2	VC2/VC3
	V3-20-8	Φ16x119/12°	9002#	RG60	V9.07.2	VC2/VC3
	V3-20-9	Φ16x102/12°	9002#	RG60	V9.07.2	VC2/VC3
	V3-20-10	Φ16x80/28°	9002#	RG60	V9.07.2	VC2/VC3
	V3-20-11	Φ16x100/42°	9002#	RG60	V9.07.2	VC2/VC3
	V3-20-12	Φ16x100/27°	9002#	RG60	V9.07.2	VC2/VC3

*Rim Hole .625"







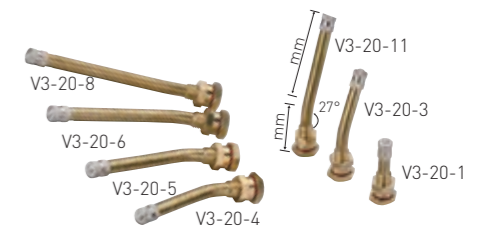

*European Style O-ring Seal Clamp-in Brass Valves

*V3.20 Series Metric Rim Hole Valves

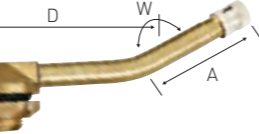
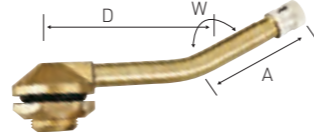
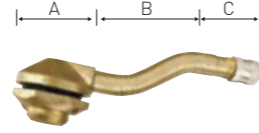
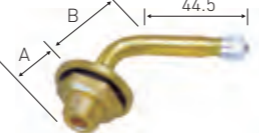
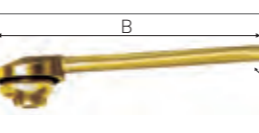
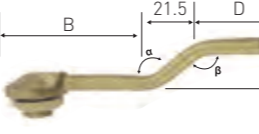

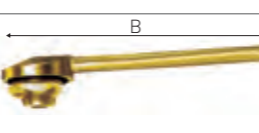
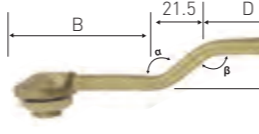
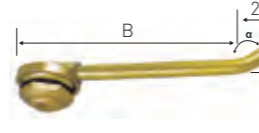
Tubeless Metal Clamp-In Valves

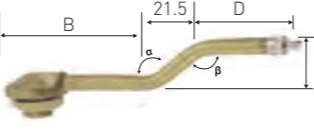
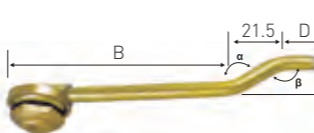
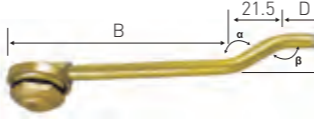
*For $\Phi 15.7(.625)$ Rim Hole

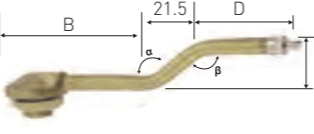
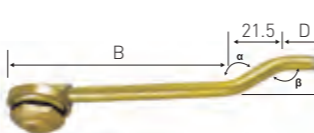
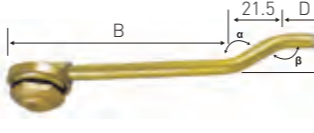
ETRO NO.	Eff. length	Parts				Image
		Core	Grommet	Nut	Cap	
V3-12-1	$\Phi 26 \times 21.5 \times 40$	9002#	9.11.4	V9.13.1	FT	
V3-12-2	$\Phi 26 \times 21.5 \times 94$	9002#	9.11.4	V9.13.1	FT	
V3-13-1	D:46.5 A:42.5 W:153°	9002#	9.11.4	V9.13.1	FT	
V3-13-2	D:30 A:29 W:126°	9002#	9.11.4	V9.13.1	FT	
V3-14-1	A:26 B:21.5 C:24.5	9002#	9.11.4	V9.13.1	FT	
V3-14-2	A:45 B:21.5 C:24.5	9002#	9.11.4	V9.13.1	FT	
V3-14-3	A:37 B:21.5 C:24.5	9002#	9.11.4	V9.13.1	FT	
V3-15-1	C:14 B:22.5 W:110°	9002#	9.11.2	V9.13.1	FT	
V3-15-2	C:11 B:15.5 W:95°	9002#	9.11.2	V9.13.1	FT	
V3-16-1	A:36 B:29 W:150°	9002#	9.11.4	V9.13.1	FT	
V3-17-1	B:3.15 A:99 W:172°	9002#	9.11.2	V9.13.1	FT	
V3-17-2	B:3.15 A:116 W:172°	9002#	9.11.2	V9.13.1	FT	
V3-18-1	B:64 D:24.5 E:14.5 W:146°	9002#	9.11.2	V9.13.1	FT	
V3-18-2	B:81 D:24.5 E:14.5 W:146°	9002#	9.11.2	V9.13.1	FT	
V3-18-4	B:51 D:37.5 E:19.5 W:138°	9002#	9.11.2	V9.13.1	FT	
V3-18-5	B:68 D:37.5 E:19.5 W:138°	9002#	9.11.2	V9.13.1	FT	
V3-19-1	B:92 D:14.5 E:145 W:147°	9002#	9.11.2	V9.13.1	FT	
V3-19-2	B:76 D:15 E:152 W:145°	9002#	9.11.2	V9.13.1	FT	
V3-19-4	B:91 D:10 E:162 W:155°	9002#	9.11.2	V9.13.1	FT	

Motorcycles & Light Truck Tubeless Valves



TRNO.	Ref Length (mm)	Rim holes (mm/in)	Parts			
			Rubber Grommet	Washer	Nut	Cap
PVR70	$\Phi 20 \times 30 \times 90^\circ$	$\Phi 11.5/.453''$				VC8-E
PVR71L	$\Phi 20 \times 45 \times 90^\circ$	$\Phi 11.5/.453''$				VC8-E
PVR32	$\Phi 15 \times 54 \times 90^\circ$	$\Phi 11.5/.453''$			SNM5	VC8-E
PVR79L	$\Phi 15 \times 72 \times 90^\circ$	$\Phi 11.5/.453''$	HRG4	HG4	SNM5	VC8-E
PVR30	$\Phi 15 \times 63 \times 90^\circ$	$\Phi 11.5/.453''$	HRG2	HG2	NH2	VC8-E

Truck

TRNO.	A	B	θ	RIM HOLE
TR-618A	32			15.9
TR-621A	39	55.5	65	15.9
TR-622A	44.5	95	90	15.9
TR-623A	39	37	65	15.9



Truck & Bus Screw-On Repair Valve

TRNO.	Stem No.	ETRTO No.	Eff. length (mm)	A	B	C	W	β	Parts	
									Core	Cap
JS-75			89.5	24	70	82				
TR-75A			95	24	76	86				
TR-76A			105	24	86	86				
TR-77A			125	24	105	86				
TR-78A			146	24	127	86				
TR-175A			134	24	115	86				
TR-177A			114	24	94	86				
TR-779A			160	24	114	86				
TRJ650-03	TRJ650-02	V5.04.1	27	80				80		
TRJ651-03	TRJ651-02	V5.04.2	32	119				90		
TRJ652-03	TRJ652-02		27	140				86		
TRJ653-03	TRJ653-02		27	64				80		
TRJ654-03	TRJ654-02		27	80				60		
TRJ655-03	TRJ655-02		27	80				74		
TRJ656-03	TRJ656-02		64	94				90		
TRJ657-03	TRJ657-02		27	102				80		
TRJ658-03	TRJ658-02		27	140				80		
TRJ659-03	TRJ659-02		48	89				90		
TRJ660-03	TRJ660-02		48	222				90		
TRJ669-03	TRJ669-02		27	64				90		
TR600HP			30	For Φ11.5(.453" dia) Rim Holes					9002#	VC8
TR602HP			49	For Φ11.5(.453" dia) Rim Holes					9002#	VC8
TR801HP			31	For Φ16(.625" dia) Rim Holes					9002#	VC8
TR802HP			49	For Φ16(.625" dia) Rim Holes					9002#	VC8

*Rubber Based Tube Valves For Truck And Bus

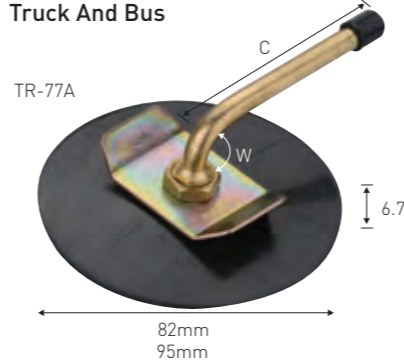

*TRJ650 Series Large Bore Tubeless Valves-Swivel Type

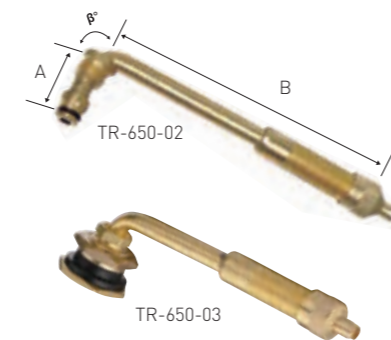

*TR600 Series High Pressure Snap-in Valves

Max Cold Inflating Pressure 720kpa/100psi at room temperature



TRNO.	A	B	C	D	α	β
V3.02.2	22.5	43			120	
V3.02.3	33	44.5			95	
V3.02.5	20.5	47.5			90	
V3.02.7	22.5	71.5			100	
V3.02.8	20.5	89.5			94	
V3.02.9	20.5	99.5			94	
V3.02.10	20.5	115			94	
V3.02.11	20	126			98	
V3.02.12	20.5	132			94	
V3.02.13	20.5	133.5			90	
V3.02.14	20.5	138.5			94	
V3.02.15	20.5	145.5			94	
V3.02.16	20.5	149.5			90	
V3.02.17	20.5	156.5			90	
V3.02.18	22.5	74.5			90	
V3.02.19	20.5	60			94	
V3.02.23	29.5	66.5			90	
V3.02.24	20.5	117			90	
V3.02.27	20	75			94	
V3.04.1	20.5	32	37		90	130
V3.04.2	20.5	38	41.5		90	153
V3.04.3	20	59	38.5		94	163
V3.04.4	20	74	40		94	144
V3.04.5	20	76	47.5		90	153
V3.04.6	20	86	47.5		90	153
V3.04.10	20.5	47	53		90	154
V3.04.11	20.5	47	63.5		90	154
V3.04.17	20	65	45		90	160
V3.04.24	20	58	47		94	164
V3.04.26	20	99	47		94	189
V3.06.1	20.5	30.5	19.5	35.5	90	139
V3.06.2	20.5	44.5	12	37.5	90	125
V3.06.3	20.5	46.5	20.5	47.5	90	140
V3.06.5	20.5	62.5	19.5	49	90	139
V3.06.6	20	79.5	19.5	37.5	90	139
V3.06.7	20.5	45.5	18.5	42.5	90	137
V3.06.8	24.5	61.5	14.5	50.5	94	153
V3.06.9	20.5	67.5	19.5	54.5	90	139
V3.06.12	23.5	71.5	19.5	25.5	90	150
V3.06.14	20	50	13	40	94	153
V3.06.15	20	60	13	40	94	153
V3.06.16	20	62	13	50	94	153
V3.06.17	20	75	13	50	94	153
V3.03.18	20.5	94	43	47	90	159

*Single Bend Type



*Double Bend Type

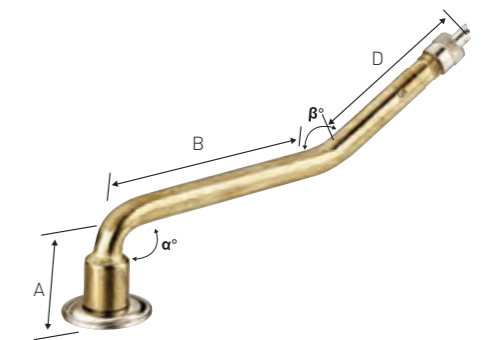

*Triple Bend Type

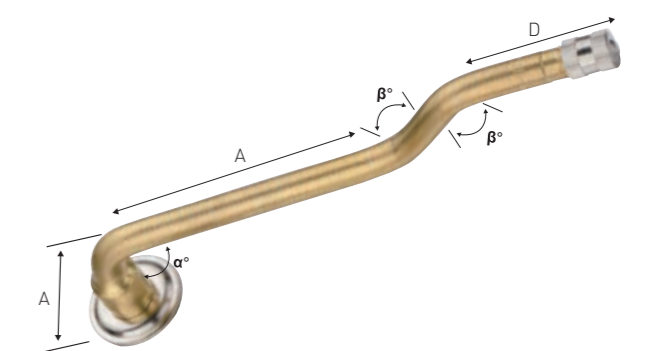

Standard Bore Valve Core

TYNO.	Feature	Barrel Gasket Color	Working Pressure Range Kg/cm ² (lbf/in ²)	Working Temperature Range
9001	Standard Type	Black	0~15(0~212)	-40~+100°C
9003	Standard Type	Black	0~15(0~212)	(-40~+212°C)
9002	High/low Temperature Resistant	Red	0~15(0~212)	-54~+150°C
9004	High/low Temperature Resistant	Red	0~15(0~212)	(-65~+302°C)
9005	Freon Resistant	White	0~35(0~496)	-20~+100°C (-4~+212°C)
9006	Freon Resistant	Green	0~35(0~496)	-20~+100°C (-4~+212°C)
9007	Low Opening Pressure	Yellow	0~15(0~212)	-40~+100°C(-40~+212°C)
9008	Gas Resistant	White	0~15(0~212)	
8001	Standard Type	Black	0~15(0~212)	-40~+100°C
8003	Standard Type	Black	0~15(0~212)	(-40~+212°C)
8002	High/low Temperature Resistant	Black	0~15(0~212)	-54~+150°C
8004	High/low Temperature Resistant	Black	0~15(0~212)	(-65~+302°C)
8005	Filter Type	Red/white	0~15(0~212)	-54~+150°C (-65~+302°C)
7001	Standard Type	Black	0~15(0~212)	-40~+100°C
7003	Standard Type	Black	0~15(0~212)	(-40~+212°C)
7002	High/low Temperature Resistant	Red	0~15(0~212)	-54~+150°C
7004	High/low Temperature Resistant	Red	0~15(0~212)	(-65~+302°C)
6001	Standard Type	Black	0~15(0~212)	-40~+100°C
6003	Standard Type	Black	0~15(0~212)	(-40~+212°C)
6002	High/low Temperature Resistant	Red	0~15(0~212)	-54~+150°C
6004	High/low Temperature Resistant	Red	0~15(0~212)	(-65~+302°C)

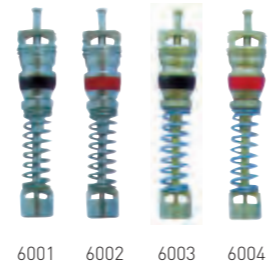
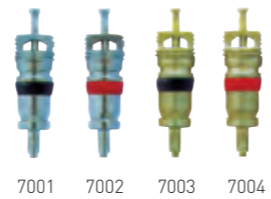
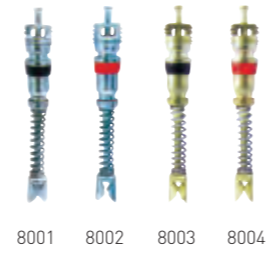

Valve Caps

Product diversification: color, appearance and Packaging can be customized.

Any Color is Possible For Tire Valve Caps



Brass & Aluminum



Brass, Plastic & Aluminum



Aluminum



Plastic



Brass



Passenger Car Extension Caps

FTNO.	Eff. Length	Total Length
EX13M	13	21
EX19M	19	26
EX32M	32	41
EX13P	13	21
EX19P	19	26
EX32P	32	41



*Metal Extension Caps



*Plastic Extension Caps

Valve Extensions

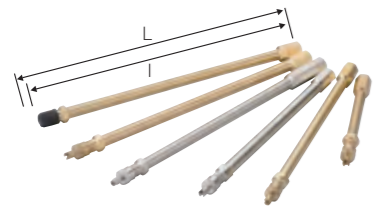

*Truck & Bus Metal Extensions

*Truck & Bus Plastic Extensions

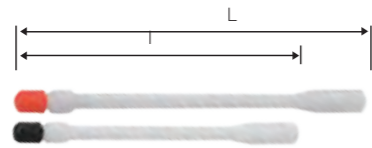

*Stainless Steel Braided Extensions

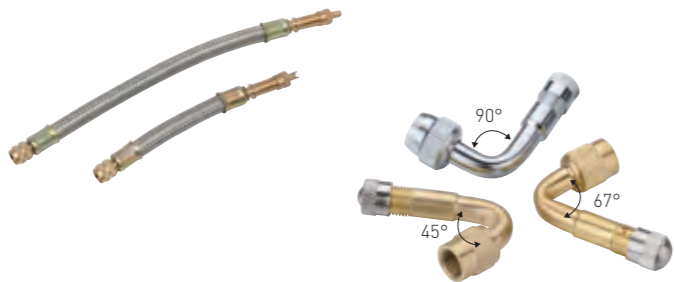

*Rubber Extensions



FTNO.	Eff. Length	Total Length
EX40M	34	40
EX60M	54	60
EX84M	78	84
EX115M	100	115
EX125M	110	125
EX142M	127	142
EX51P	33.5	51
EX71P	53.5	71
EX95P	77.5	95
EX115P	97.5	115
EX125P	107.5	125
EX150P	132.5	150
EX170P	152.5	170
EX180P	162.5	180
EX200P	182.5	200
EX64RM	Extensions	85
EX125RM	Extensions	125
EX180RM	Extensions	180
EX250RM	Extensions	250
EXMU	With U-shape Clip	210
EXFM	With U-shape Clip	250
EX75R	Extensions	75
EX100R	Extensions	100
EX125R	Extensions	125
EX150R	Extensions	150
EX180R	Extensions	180
EX210R	Extensions	210
EX250R	Extensions	250
EX270R	Extensions	270
EX300R	Extensions	300
EX210R-FVE1	Extensions	210
		90°
5624292	Extensions	67°
		45°

Air Chucks

European Style Clip-on Air Chucks



AC04

AC106

AC108C

AC208

South-eastern Asian Style



VH112

VH113

Holders for Extensions



FVE1

FVE2

FVE3

Tire Studs

Because studdable tires are manufactured with different tread depths, studs are manufactured in different lengths that must be matched to the depth of the holes molded in the tire (see illustration below). Stud sizes are identified by their Tire Stud Manufacture Index (FTS) number or the stud's overall length in millimeters (mm).

STUD INSERTION

As studded tires are driven through winter, the studs are designed to wear at a rate similar to the tread rubber with the tungsten carbide pins wearing a little slower than the metal housings around them.

This retains the stud's effectiveness to continue to chip into the ice as the tire wears. However, as with all tires, once studded tires wear down to approximately 5/32" of remaining tread depth, they will lose effectiveness in deep snow and a new set of tires should be installed if deep snow driving is still anticipated.

Density(g/ cm³):12.5
 TRS(N/ MM²):1800
 Hardness(HRA):90.1
 Porosity(ISO)A02B02
 Free carbon and graphite phase:C02

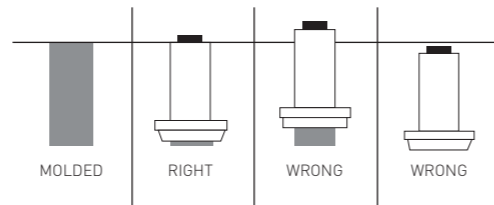

FTS8.8 Series

FTS12



Length: 11(MM)
 Head Diameter: 8.8(MM)
 Shaft Diameter: 4.8(MM)
 Pin Length: 5.2(MM)
 Weight: 2.02(Grams)
 Colour: Silver
 Surface: Zinc Coated

FTS15



Length: 13(MM)
 Head Diameter: 8.8(MM)
 Shaft Diameter: 4.8(MM)
 Pin Length: 5.2(MM)
 Weight: 2.19(Grams)
 Colour: Blue
 Surface: Zinc Coated

FTS13



Length: 12(MM)
 Head Diameter: 8.8(MM)
 Shaft Diameter: 4.8(MM)
 Pin Length: 5.2(MM)
 Weight: 2.03(Grams)
 Colour: Gold
 Surface: Zinc Coated

FTS16



Length: 15(MM)
 Head Diameter: 8.8(MM)
 Shaft Diameter: 4.8(MM)
 Pin Length: 5.2(MM)
 Weight: 2.44(Grams)
 Colour: Blue
 Surface: Zinc Coated

FTS17



Length: 16(MM)
 Head Diameter: 8.8(MM)
 Shaft Diameter: 4.8(MM)
 Pin Length: 5.2(MM)
 Weight: 2.58(Grams)
 Colour: Gold
 Surface: Zinc Coated

FTS8 Series

FTS-A



Length: 10(MM)
 Head Diameter: 8(MM)
 Shaft Diameter: 5.3(MM)
 Pin Length: 5.2(MM)
 Weight: 1.7(Grams)
 Colour: Silver
 Surface: Zinc Coated

FTS-B



Length: 11(MM)
 Head Diameter: 8(MM)
 Shaft Diameter: 5.3(MM)
 Pin Length: 5.2(MM)
 Weight: 1.8(Grams)
 Colour: Silver
 Surface: Zinc Coated

FTS8-C Series

FTS-C



Length: 10(MM)
 Head Diameter: 8(MM)
 Shaft Diameter: 6.5(MM)
 Pin Length: 5.2(MM)
 Weight: 1.8(Grams)
 Colour: Silver
 Surface: Zinc Coated

FTS-D



Length: 11(MM)
 Head Diameter: 8(MM)
 Shaft Diameter: 5.3(MM)
 Pin Length: 5.2(MM)
 Weight: 1.9(Grams)
 Colour: Silver
 Surface: Zinc Coated





TIRE PRESSURE GAUGES

Tire Pressure Gauges

Digital Tire Pressure Gauges

* Digital tire pressure gauges can be customized in any styles

TPG03

Pressure range:	3-100psi,0.20-6.90bar,20-700kpa,0.2-7.05kgf/cm ²
PressureUnit:	psi, bar, kpa, kgf/cm ² (optional)
Resolution:	0.5psi/0.05bar
Extra Function:	Flashlight/ Emergeny life hammer/ Seatbelt cutter/ Compass Auto shut off



TPG04

Pressure range:	3-100psi,0.20-6.90bar,20-700kpa,0.2-7.05kgf/cm ²
Pressure Unit:	psi,bar,kpa,kgf/cm ² (optional)
Resolution:	0.5psi/0.05bar
Power:	CR2032 3V lithium coin cell
Extra Function:	Back-Lit LCD and light on gauge's head Auto shut off



TG02

Pressure range:	3-100psi,0.20-6.90bar
Tire tread depth range:	0-15.8mm
Pressure Unit:	psi, bar
Resolution:	0.5psi/0.05bar
Power:	CR2032 3V lithium coin cell
Extra Function:	Measure tire tread depth Auto shut off Keyring



TG03

Pressure range:	3-100psi,0.20-6.90bar ,20-700kpa,0.2-7.05kgf/ cm ²
PressureUnit:	psi,bar,kpa,kgf/cm ² (optional)
Resolution:	0.5psi/0.05bar
Power:	CR2032 3V lithium coin cell
Extra Function:	Auto shut off Accuracy: ≤±1psi



TG004

Pressure range:	3-100psi,0.20-6.90bar ,20-700kpa,0.2-7.05kgf/cm ²
Pressure Unit:	psi,bar,kpa,kgf/cm ² (optional)
Resolution:	0.5psi/0.05bar
Power:	CR2032 3V lithium coin cell 3XAG13 battery
Extra Function:	Back-Lit LCD and light on gauge's head for easy use in dark condition Auto shut off



Pencil-like Tire Air Gauges

FT871K



Content: vibrant color, the eye catching display include 8 pieces of passionial tire gauge, plastic head, metal body,4 side plastic bar
Calibrated: 10-50lbs scales selection(bar.kpa.kgf/cm².psi)

FT123



Content: metal body round rules.
Calibrated: 10-120psi

Tire Tread Depth Gauge

FT-1420/FT-190

- **Content:** metal tube, plastic head, plastic bar
- **Appearance:** metal stalk son, easy to carry
- **Using:**push and pull the tail of the depth of instrument

FT105



Content: vibrant color, chrome-plated plastic or zinc head.4 side plastic bar. aluminum tube
Calibrated: 10-50lbs or 10-100 lbs scales selection(bar.kpa.kgf/cm².psi)

FT135-C



Content: metal body, iron bar or plastic bar



FT-1420



FT-190

Tire Pressure Gauges

FTT823



Content: Brass stem, metal body, acrylic lens
Calibrated: 10-60psi

FTT286



Inflator gun: Aluminum body, color matte with chrome plated friction ring
Calibrated: 0-160lbs or 0-220 lbs scales selection(bar.kpa.kg/cm².psi)

FTT654A



Inflator gun: Aluminum body, color matte with chrome plated friction ring
Calibrated: 0-160lbs or 0-220 lbs scales selection(bar.kpa.kg/cm².psi)

FTT287



Content: Long Chuck with hose,1/4' coupler

FTT654-1



Content: Inflating Gun with extension rubber hose, metal body
Calibrated: 0-160lbs or 0-220lbs scales selection(bar.kpa.kgf/cm².psi)

FTT622



Content: Zinc alloy body color matte, with chrome plated friction ring, acrylic lens.(Vibrant color)
Calibrated: 10-100lbs scales selection(bar. kpa. kgf/ cm².psi)

FTT654B



Content: Aluminum body, color matte with plastic coated friction ring
Calibrated: 0-160lbs or 0-220lbs scales selection(bar.kpa.kgf/cm².psi)

FTT623



Content: Brass stem, drawn steel case with friction ring and acrylic lens, needle holds reading until released.
 Diameter of 2.0"metal body
Calibrated: 0-60lbs scales selection(bar. kpa. kgf/ cm².psi)

Air Chucks

FTT130

Dual-foot Chuck, Angled 1/4"Female



FTT130-1

Dual-foot Chuck, Angled 1/4"Female



FTT136

Zinc-Alloy head chrome plated 1/4"



FTT138

Black handle, Zinc-Alloy head chrome plated 1/4",5/16" hose barb



FTT139

Red handle, Zinc-Alloy head chrome plated 1/4",5/16" hose barb



LUG NUTS BOLTS & WHEELSPACERS ADAPTERS



Lug Nuts



1-PC ACRON SHORT

Thread Size	Part#
7/16	1002S
1/2	1004S
12mm 1.25	1006S
12mm 1.50	1007S
12mm 1.75	1012S



MUSTANG LUG NUT

Thread Size	Part#
3/8	1001M
7/16	1002M
1/2	1004M
12mm 1.25	1006M
12mm 1.50	1007M
12mm 1.75	1012M
14mm 1.50	1009M
14mm 2.00	1014M



1-PC ACORN

Thread Size	Part#
3/8	1001
7/16	1002
1/2	1004
12mm 1.25	1006
12mm 1.50	1007
12mm 1.75	1012
14mm 1.50	1009
14mm 2.00	1014



1-PC ACORN HEAT TREATED

Thread Size	Part#
3/8	1001H
7/16	1002H
1/2	1004H
12mm 1.25	1006H
12mm 1.50	1007H
12mm 1.75	1012H
14mm 1.50	1009H
14mm 2.00	1014H



1-PC ACORN

Thread Size	Part#
3/8	1001
7/16	1002
1/2	1004
12mm 1.25	1006
12mm 1.50	1007
12mm 1.75	1012
14mm 1.50	1009
14mm 2.00	1014



XL ACORN

Thread Size	Part#
14mm 1.50	1009XL
14mm 2.00	1014XL

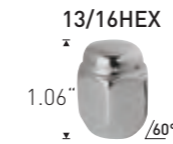

2-PC ACORN

Thread Size	Part#
7/16	1202S
1/2	1204S
12mm 1.50	1207S
12mm 1.25	1206S



2-PC ACORN

Thread Size	Part#
7/16	1202
1/2	1204
1/2LH	1205
12mm 1.25	1206
12mm 1.50	1207
12mm 1.75	1212
14mm 1.50	1209

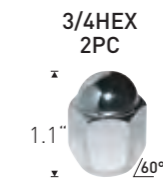

2-PC SHORT DUALIT ACORN

Thread Size	Part#
7/16	1352AC
1/2	1354AC
12mm 1.25	1356AC
12mm 1.50	1357AC



2-PC ACORN SHORT DUALIT ACORN

Thread Size	Part#
7/16	1552AC
1/2	1554AC
12mm 1.25	1556AC
12mm 1.50	1557AC



DUALIE ACORN

Thread	Part#
14mm 1.50	3109A
9/16	3110A
9/16LH	3120A
5/8-18	3130A
5/8-18LH	3140A

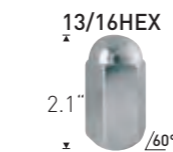

DUALIE ACORN

Thread	Part#
14mm 1.50	3109F
14mm 2	3114F
9/16	3110F
9/16LH	3120F
5/8-18	3130F



2PC BULGE ACORN SHORT

Thread Size	Part#
7/16	1702
1/2	1704
12mm 1.25	1706
12mm 1.50	1704
12mm 1.75	1712
14mm 1.50	1709
14mm 2.00	1714

BLUE&BLACK&RED



BULGE ACORN

Thread Size	Part#
7/16	1902
1/2	1904
12mm 1.25	1906
12mm 1.50	1907
12mm 1.75	1912
14mm 1.50	1909
14mm 2.00	1914
9/16	1910



1-PC ACORN LONG

Thread Size	Part#
7/16	1902L
1/2	1904L
12mm 1.25	1906L
12mm 1.50	1907L
12mm 1.75	1912L
14mm 1.50	1909L
14mm 2.00	1914L
9/16	1910L

Lug Bolts

CONE SEAT

Part#	Thread Size	H	L
952		23mm/0.91"	50mm/1.97"
953		40mm/1.57"	67mm/2.64"
954		27mm/1.06"	54mm/2.13"
955		33mm/1.30"	58mm/2.28"
17C-4572-06	12mm 1.50	45mm/1.77"	72mm/2.83"
17C-5576-07		55mm/2.16"	76mm/2.99"
17C-4061-07		40mm/1.57"	61mm/2.4"
17C-2450-07		24mm/0.95"	50mm/1.97"
956		31mm/1.22"	56mm/2.20"
963		23mm/0.91"	50mm/1.97"
966		28mm/1.10"	55mm/2.17"
981		40mm/1.57"	67mm/2.64"
983	14mm 1.50	45mm/1.77"	66mm/2.60"
17C-2450-09		24mm/0.95"	50mm/1.97"
17C-3057-09		30mm/1.18"	57mm/2.24"
17C-3960-09		39mm/1.54"	60mm/2.36"
969	12mm 1.25	33mm/1.30"	58mm/2.28"
979	12mm 1.75	27mm/1.06"	54mm/2.13"
982	7/16	18mm/0.71"	47mm/1.85"
978	1/2	27mm/1.6"	54mm/2.13"
17C-2652-18	14mm 1.25	26mm/1.02"	52mm/2.05"



Lug Bolt Caps

Colours available upon request

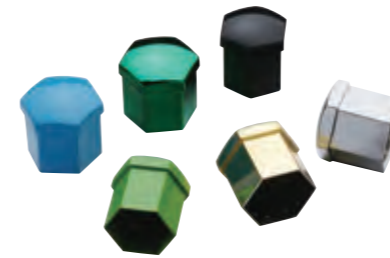

Site:HEX17,19,21

Wheel Locks



Hub Centric Rings

Any Design And Size Can Be Ordered
Colours available upon request



		From	To	Thickness	I.D.	O.D.
4Lug Part	400	4*100mm	4*100mm	1"		
	400	4*100mm	4*100mm	1.25"		
	402	4*100mm	4*4.5"	1"	71mm	150mm
	403	4*4.25"	4*100mm	1"		
	404	4*4.5"	4*4.5"	1.5"		
5Lug Part	500	5*100mm	5*100mm	1"	56.11mm	
	501	5*135mm	5*4.5"	1.5"	87.1mm	176mm
	502	5*4.5"	5*4.5"	1.25"		164mm
	503	5*4.75"	5*4.75"	2"	74mm	164mm
	504	5*5"	5*4.5"	1.25"	78mm	164mm
6Lug Part	505	5*5.5"	5*4.5"	2"	108mm	176mm
	600	6*5.5"	6*5.5"	1.5"	108mm	176mm
	601	6*5.5"	6*5.5"	1.5"	78mm	176mm
8Lug Part						14mm*1.50
	800	8*170mm	8*170mm	2"	125mm	216mm
	801	8*200mm	8*200mm	2"	125mm	246mm
	802	8*6.5"	8*6.5"	2"	126.15mm	216mm

BALL SEAT

Part#	Thread Size	H	L
951		27mm/1.06"	54mm/2.13"
957		39mm/1.54"	63mm/2.48"
959	12mm 1.50	60mm/2.36"	80mm/3.15"
961		33mm/1.30"	58mm/2.28"
980S		24mm/0.94"	50mm/1.97"
980C		24mm/0.94"	50mm/1.97"
1814	12mm 1.25	28mm/1.10"	54mm/2.13"
1804L		39mm/1.54"	65mm/2.56"
962		31mm/1.22"	56mm/2.20"
964		23mm/0.91"	50mm/1.97"
965		51mm/2.01"	70mm/2.76"
985	14mm 1.50	39mm/1.54"	60mm/2.36"
986		28mm/1.10"	55mm/2.17"
987		55mm/2.17"	82mm/3.23"
988		60mm/2.36"	87mm/3.43"
989		65mm/2.56"	92mm/3.62"



Wheel Spacer



WS001

Description: 4Lug(100mm/4.25 to 120mm/4.75BC) and 6 on 4.5-8mm/5/16" Thick



WS003

Description: 5Lug(100mm/4.25 to 120mm/4.75BC)5mm/3/16"Thick



WS004

Description: 5Lug(108mm/4.25 to 135mm/5.00BC)8mm/5/16" Thick



WS005

Description: 5Lug(108mm/4.25 to 135mm/5.0BC)12mm/1/2"Thick



WS006

Description: 7Lug(150mm-BC)-6mm/1/4"Thick



WS007

Description: 5Lug(100mm/4.25 to 120mm/4.75BC)8mm/5/16"Thick



WS008

Description: 4/5Lug(100mm/4.25 to 120mm/4.75BC) 5mm/3/16"Thick



WS002

Description: 4/5 Lug(100mm/4.25 to 120mm/4.75BC)3mm/1/8"Thick

Wheel Adapter

FEATURES

Material:Forged Aluminum 6061-T6 7075-T6
Finish:CNC machined,Anodized
Bolt/Stud:Bolt or Stud
Thick:20-50mm

Hubcentric wheel adapter is made of lightweight aircraft aluminum alloy.After being CNC machined and anodized,it becomes incredibly strong,precise,and durable.



O.D	H/PCD	Hub	Bore	Thread Type
139	4/100	56.1		M12xP1.50
139	4/100	56.1		M12xP1.50
139	3/112	57.1		M12xP1.50
139	4/108	57.1		M14xP1.50
149	5/112	57.1		M14xP1.50
149	5/112	57.1		M14xP1.50
169	5/130	71.6		M14xP1.50
169	5/130	71.6		M14xP1.50
179	5H/139.7	108		M12xP1.25xL27
179	5H/139.7	108		M12xP1.25xL27
149	4H/114.3	73		M12xP1.25xL23
149	4H/114.3	73		M12xP1.25xL23
149	5H/114.3	73		M12xP1.25xL23
149	4H/100	54.1		M12xP1.50xL23
149	4H/100	54.1		M12xP1.50xL23
149	5H/100	54.1		M12xP1.25xL23
149	5H/100	54.1		M12xP1.25xL23

TIRE REPAIR TOOLS



Different Needles



Tire Repair Tools

Pistol Grip Tools



4-100 Straight handle

4-102 L handle

4 -101-1 L handle

4-106 plastic L handle

4-105 Plastic T handle

Heavy-duty Chrome Plated Steel T-handle Tools



TRT75PR-1

TRT75MR

Heavy-duty Zinc Alloy T-handle Tools



TRT75PR

TRT75NR-1

Valve Tool



Stitchers & scrapers



NOTE:

FT42-2:Stitcher 38mmX2mm
 FT42-3:Stitcher 38mmX3mm

Wheel Weight Pliers



Tire Repair Kits

KT-1 6 pcs Tire Repair Kit



- 1pc plastic T handle needle
- 1pc plastic T handle spiral probe
- 3 pcs 4'cold-mending rubber strip
- 1pc rubber cement

KT-2 7 pcs Tire Repair Kit



- 1pc plastic straight handle needle
- 1pc plastic straight handl spiral probe
- 5 pcs 4'cold-mending rubber strip

KT-3 8 pcs Tire Repair Kit



- 1pc plastic T handle needle
- 1pc plastic T handle spiral probe
- 5 pcs 4'cold-mending rubber strip
- 1pc rubber cement

KT-4 7 pcs Tire Repair Kit



- 1pc plastic big Lhandle needle
- 1pc plasticbig Lhandle spiral probe
- 5 pcs 4'cold-mending rubber strip
- 1pc rubber cement



KTR001



KTB002

KTR001/KTB002

Heavy-duty Alu T-handle insert Tool Kit
 Heavy-duty Alu T-handle probe Cement Tool
 Replacement Tool
 Tire String



Tube/Tubeless Tire Repairs Patches
 black colour with orange base

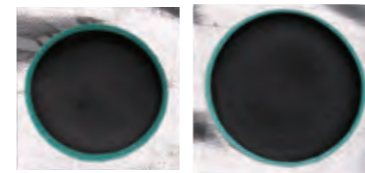

Universal Round Patches

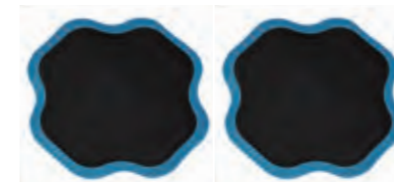

Euro Style Bias-Ply Patches



Euro Style Radial Patches

Euro Style Patches

PRODUCTION UNITS	DESCRIPTION	SIZE(mm)	PCS/BOX
	ROUND	52	16
	ROUND	40	25
Tube/Tubeless Tire Repairs Patches black colour with orange base	ROUND	30	36
	ROUND	25	64
	OVAL	72x40	15
	OVAL	50x32	24
	OVAL	34x24	48
Universal Round Patches	ROUND	75	36
	ROUND	52	64
	ROUND	40	100
	ROUND	30	150
Euro Style Bias-Ply Patches	1PLY	75x75	20
	2PLY	105x105	10
	4PLY	135x135	10
	4PLY	175x175	10
	4PLY	215x215	10
	6PLY	260x260	5
	6PLY	300x300	5
	8PLY	350x350	5
Euro Style Radial Patches	1PLY	55x75	20
	1PLY	65x105	20
	2PLY	80x125	10
	3PLY	90x135	10
	3PLY	90x155	10
	4PLY	130x190	10
	4PLY	125x215	5

US Style Patches

PRODUCTION UNITS	DESCRIPTION	SIZE(mm)	PCS/BOX
Universal Round Patches	ROUND	65	30
	ROUND	75	50
	ROUND	32	80
	ROUND	38	70
	ROUND	45	55
	ROUND	55	45
	ROUND	80	30
US Style Bias-Ply Patches	BP-0,1PLY	60	25
	BP-1,1PLY	75	20
	BP-2,2PLY	90x90	10
	BP-3,2PLY	100x100	10
	BP-4,4PLY	130x130	10
	BP-5,4PLY	165x165	10
	BP-6,6PLY	240x240	5
BP-7,6PLY	290x290	5	
US Style Radial Patches	CT-10,1PLY	45x75	20
	CT-12,,1PLY	60x110	10
	CT-20,2PLY	75x125	10
	CT-14,2PLY	75x145	10
	CT-22,2PLY	75x165	10
	CT-24,3PLY	75x215	10
	CT-26,3PLY	75x250	10
	CT-33,3PLY	100x125	10
	CT-40,3PLY	100x200	10
	CT-37,3PLY	125x170	10
CT-42,4PLY	125x250	10	
CT-44,4PLY	125x325	10	



Universal Round Patches



US Style Bias-Ply Patches



US Style Radial Patches

Patch Plug

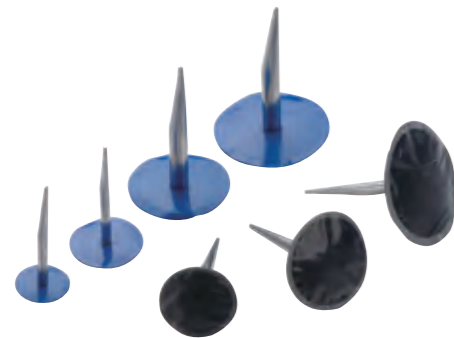

FPP
 46*6MM 24pcs/box 36boxes/case
 60*6MM 24pcs/box 27boxes/case
 50*9MM 24pcs/box 27boxes/case
 60*9MM 24pcs/box 27boxes/case

Insert Seals

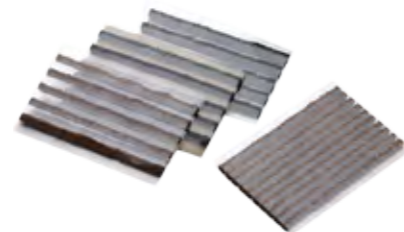

FS02
Color: Black,Brown
Diameter: 6mm,4.5mm,3.5mm
Length: 4",8"



Industrial Gloves

We are providing two types of powder free gloves ,Nitrile gloves and Latex gloves . They all provide a great deal of flexibility and stretchiness, snap-back to their original shape with ease, Long periods of time for wearing, for they cause minimal hand fatigue.

Nitrile Glove



Nitrile Glove (Powder Free)

Material: Nitrile
Size: Small, Medium, Large, X-Large
Color: Black, Blue, White, Green, Orange
Length: 9 and 12 inch
Packaging: 100pieces per box
Usage: Single use only
Storage conditions: between 10°C to 30°C Direct sunlight should be avoided

Latex Glove

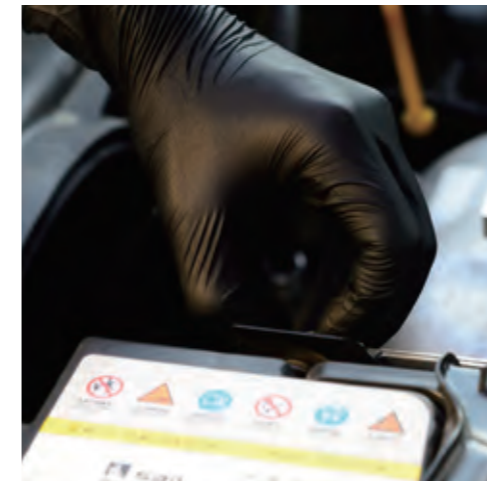

Latex Glove (Powder Free)

Material: Latex
Size: Small, Medium, Large, X-Large
Color: Colour available upon request
Length: 9 and 12 inch
Packaging: 50pieces or 100pieces per box
Usage: Single use only
Storage conditions: Between 10°C to 30°C Direct sunlight should be avoided



WHEELS

Wheels



FX008



FX014



FX021



FX024



FX025



FX029



FX030



FX031



FX032



FX033



FX034



FX035



FX036



FX037



FX038



FX039

Art No.	Size	PCD	CB	ET
FX-008	15X6	4-100	57.1	42
FX-014	15X6	6-139.7	102.4	40
FX-021	16X6.5J	5-110	65.1	39
FX-025	16X6.5J	5-114.3	71.5	39
FX-029	17X16.5J	5-114.3	71.5	40
FX-030	17X6.5	5-120	67.1	40
FX-031	16X6.5	5-100	57.1	42
FX-032	16X6.5J	5-114.3	64.1	55
FX-033	15X6	5-100	54.1	40
FX-034	16X7	5-120	64.1	50
FX-035	15X6	5-114.3	71.5	7
FX-036	15X10	5-114.3	110	-44
FX-037	15X8	5-127	84	10
FX-038	16X6	5-114.3	84	6
FX-039	15X8	6-139.7	108.7	30